



SUBARU



**FORESTER** |



## Drive into adventure.

Face new challenges. Explore the great outdoors. Do all the things you always wanted to do. It's easy with the Forester's tough and powerful look that triggers your desire for adventure. Enjoy all your outdoor adventures while keeping everyone happy, comfortable, and safe.

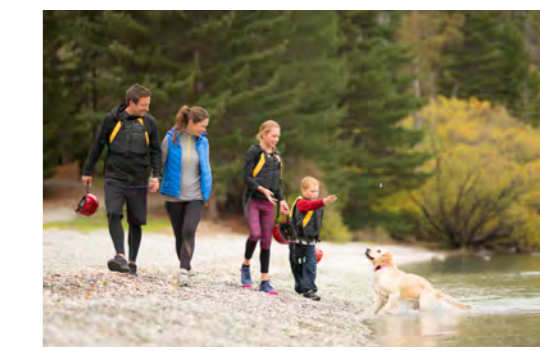



## Go anywhere. Try anything.

The redesigned Forester offers comfort, safety, and versatility to support you through all your daily adventures—while encouraging you to go on new ones. With a bolder, more powerful SUV design and the capability to back it up, the Forester gives you the peace of mind from knowing everyone's enjoying their time.

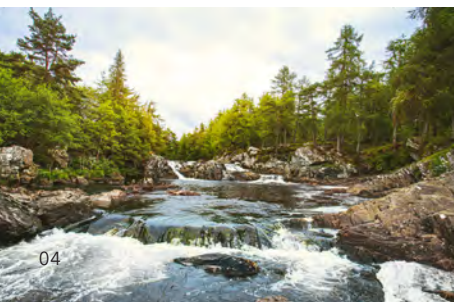



## Performance you can trust. Capability you can feel.

The Forester gives you total driving confidence with its fun-to-drive nature, responsive handling, and outstanding ride comfort. Balanced and stable around turns even with its SUV height, the Forester's compact body is easily manoeuvrable and carefully engineered to reduce fatigue on extended adventures for an enjoyable driving experience for all. And with Symmetrical All-Wheel Drive and the improved X-MODE, you can reach your destination with comfort and peace of mind.



### X-MODE and Hill Descent Control

Choose between [SNOW/DIRT] or [D.SNOW/MUD] for confident and secure driving on rough roads with the dual-function X-MODE. Instead of turning off at increased speeds, the improved system keeps your selected mode on standby to automatically restore it once you return to lower speeds, so you can focus on driving without having to keep turning it back on. Plus, Hill Descent Control helps maintain a controlled and constant speed even on slippery downhill, adding even more peace of mind to your drive.\*1\*2

### SI-DRIVE\*3

Select Intelligent Mode for balanced, smooth, and environmentally friendly performance, or Sport Mode for an immediate and linear torque-rich throttle response for sporty and smooth driving at any speed. What's more, e-Active Shift Control\*4 provides motor assist when necessary during sporty driving for powerful acceleration.

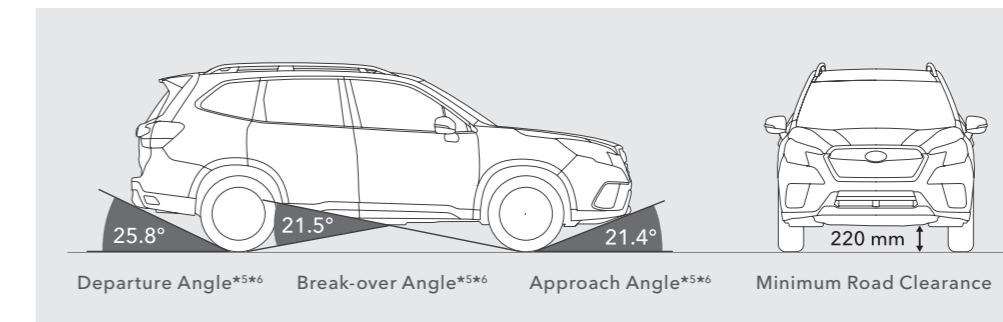

### High Ground Clearance

The Forester was designed for not only high SUV ground clearance, but also with careful consideration for approach, departure, and break-over angles. All have been optimised to help you conquer obstacles without sustaining damage or getting stuck.

\*1 Dual-function X-MODE only available on Sport and premium models.

\*2 Driver is always responsible for safe and attentive driving. Effectiveness of Hill Descent Control depends on many factors such as vehicle maintenance, weather, tyre, and road conditions.

\*3 Optional.

\*4 Available only on SUBARU e-BOXER vehicles.

\*5 When equipped with 18-inch wheels (excluding SUBARU e-BOXER vehicles).

\*6 Measured by JIS.



## Plenty of space for all your memories.

An expanded cargo area, easier-to-use power rear gate\*1, a cargo light, and upper cargo hooks\*2 are just some of the things that make the Forester the most versatile and convenient yet. Supportive of even the most active lifestyle, Forester is ready to help you do all the things you love doing, and make each adventure more meaningful.



### 01 Cargo Area

The wide opening and square design make it easier to organise, load, and unload even large objects without need to tilt them. The backs of the 60/40-split folding rear seats have been optimised for a flat cargo floor that makes loading long items easy. Plus, the sides of the cargo area are made of easily wiped-clean, durable material on which dirt and scratches are hardly noticeable, so you can enjoy any outdoor activity with peace of mind.

### 02 Power Rear Gate\*1

The power rear gate allows access to the cargo space with a single switch, even when your hands are full. The inner lock switch lets you conveniently close the rear gate and lock all doors at the same time.

### 03 Cargo Hooks

The 12V power supply, rear seat folding switch, and bag hooks are consolidated in the same area for ease of use. Cargo net hooks allow convenient luggage net use while two upper cargo hooks\*2 allow more effective use of the tall cargo area when parked.

\*1 Optional.  
 \*2 Not for hanging heavy items. Loading capacity of each upper hook is 3kg. Please ask your authorised Subaru retailer for more details.



## Enjoyment for everyone on the road.

The Forester provides comfort to every passenger, in every seat. Its convenience begins even before you enter the vehicle, as the door openings were designed for easy seat access for anyone. The orange and dark grey highlights exclusive to Sport model add refinement to the comfortable, spacious, and quiet cabin, while the seats and doors are lined with soft-touch material that's easy to clean.



### Centre Console Box

The centre console box compartment is large enough to store your electronic devices like small tablets. There's also a 12V power socket inside for your convenience.



### Power Sunroof\*

The available inner-sliding sunroof's large opening provides a sense of spaciousness while leaving plenty of headroom for all passengers.

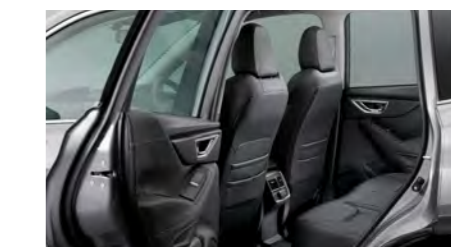

### Convenient Seat Access

Seat height, side sill placement, and door pillar design allow smooth seat access for rear passengers.



### Side Sill Steps

The rear side sill steps are wide, flat, and have a slip-resistant surface for convenient roof rail use.

\* Optional.



## Personalised comfort for any driver.

### Driver Monitoring System\*

Driver Monitoring System\* is a state-of-the-art safety support system that utilises a dedicated camera and facial recognition software to monitor fatigue or lack of attention. It recognises up to five pre-registered drivers to provide customised driver settings for a comfortable, convenient, and personalised driving experience.



#### Alert

Driver Monitoring System alerts the driver via audio and visual warnings if it determines the driver is distracted or drowsy.



#### Driver Setting Auto Adjustment

Regardless of age or body type, Driver Monitoring System automatically adjusts the seat position, door mirrors, and air conditioning to the driver's pre-registered settings.

\* Optional.

The driver is always responsible for safe and attentive driving and observance of traffic regulations. Please do not depend solely on the Driver Monitoring System for safe driving. There are limitations to the features of the Driver Monitoring System. See Owner's Manual for complete details on system operation and limitations. Please ask your retailer for more details.

## Feel connected, wherever you go.

Safely enjoy the conveniences of smartphone connectivity while on the go, with services such as Apple CarPlay\*<sup>1</sup> and Android Auto\*<sup>2</sup>. Designed with both advanced functionality and ease of use in mind, the Forester provides you with advanced infotainment functions and intuitive controls. Combined with comfortable front seats that encourage a natural driving position, you'll feel right at home, no matter how far you go.



### Apple CarPlay\*<sup>1</sup> and Android Auto\*<sup>2</sup>

Use today's most popular apps with Apple CarPlay\*<sup>1</sup> and Android Auto\*<sup>2</sup>. Voice recognition capabilities allow hands-free use, keeping everybody safe while reducing distractions when you're on the road.



### Multifunction Display\*<sup>3</sup>

The 6.3-inch LCD multifunction display at the top of the instrument panel provides you and your passengers with useful information in an easy-to-understand view. When the navigation system is in use, it connects to the multifunction display and shows turn-by-turn information when approaching intersections or turns.

\*<sup>1</sup> Apple CarPlay is a trademark of Apple Inc., registered in the U.S. and other countries.

\*<sup>2</sup> Android and Android Auto are trademarks of Google Inc.

\*<sup>3</sup> Optional.

Apple CarPlay and/or Android Auto may not be available for all models and regions. Please contact your local authorised Subaru retailer for more details.



## Trust What's Inside

Subaru's core technologies provide every Subaru with the performance, comfort, safety, and reliability that deliver enjoyment and peace of mind to every passenger.

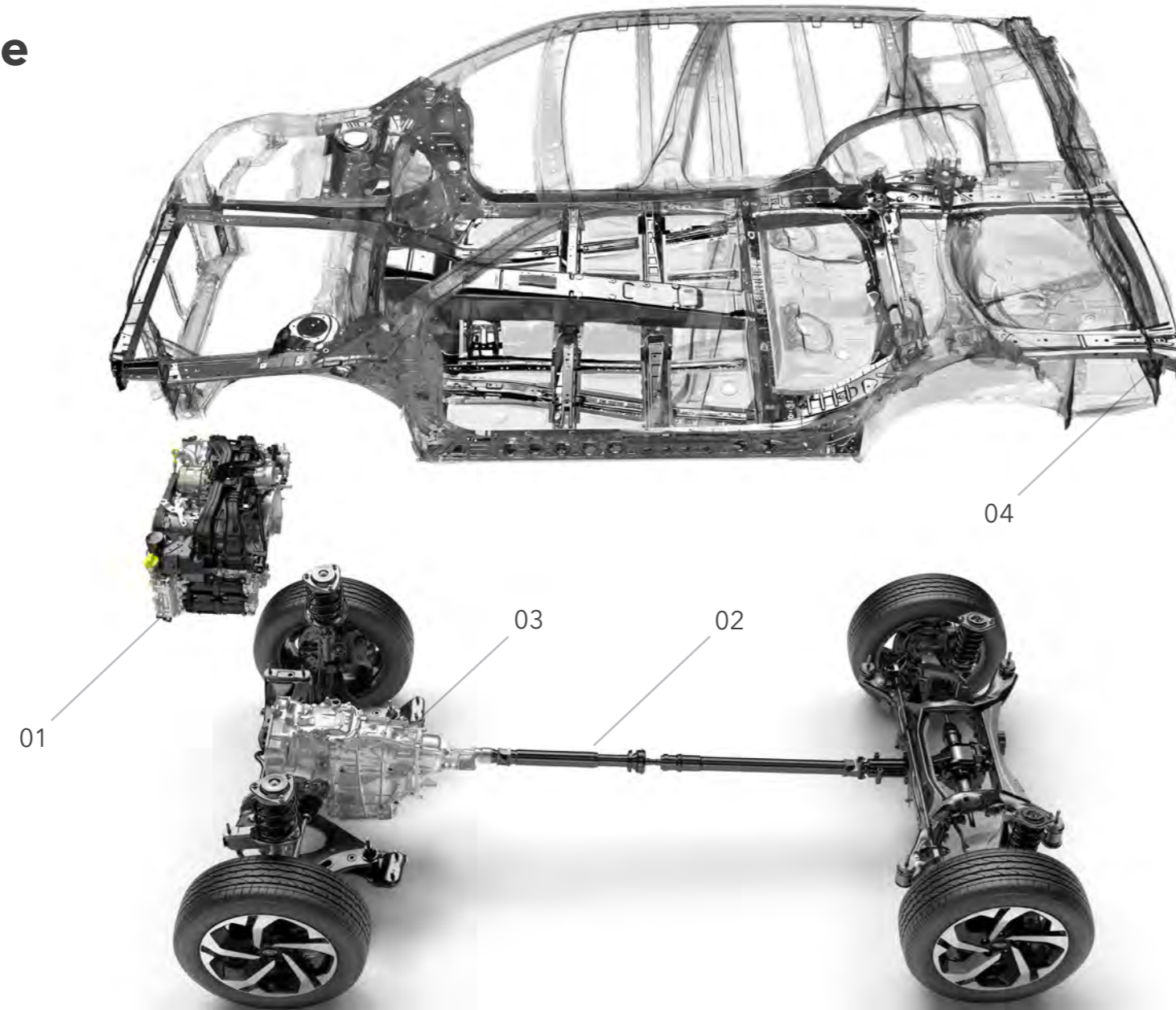

01

### SUBARU BOXER Engine

A boxer engine, or a horizontally opposed engine, is an engine configuration in which its pistons move toward each other in a horizontal direction. Subaru has been committed to the SUBARU BOXER engine for its many advantages over other engine types, providing durability and reliable performance in its vehicles.

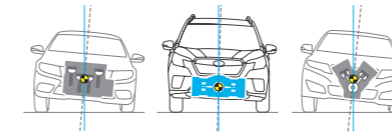

#### Naturally Balanced

The engine's flat design is inherently rigid and self-balancing, generating less vibration than other engine types.

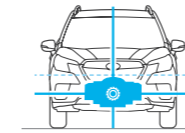

#### Increased Stability

The low centre of gravity and flat design give it better side-to-side stability than other engine types.

02

### Symmetrical All-Wheel Drive (AWD)

Subaru's Symmetrical AWD distributes power to all wheels for better traction on wet and slippery roads. Laid out in a horizontally symmetrical plane, this system has a well-balanced low centre of gravity design for a more stable and safer ride.

03

### Lineartronic + Active Torque Split AWD

Lineartronic adjusts to any ratio in its range for smooth and stepless gear changes that keep the engine in its most efficient range for efficient and smooth acceleration, driving performance and better fuel efficiency. It comes paired with Subaru's active torque split AWD system. Its default torque is well-balanced front to rear and adjusts in response to real-time traction conditions.

04

### Subaru Global Platform

The Subaru Global Platform is the underlying platform that will underpin the next generation of Subaru vehicles. Enhancing all-around safety and performance, it goes beyond better performance to offer a driving feel you can only find in a Subaru. It's the future of Subaru—and delivers even more enjoyment and peace of mind to all drivers and passengers.

#### More Fun to Drive

More responsive handling allows you to steer the car just as intended for better hazard avoidance. Even with its high ground clearance, the Forester securely hugs the road around turns, resulting in a car that's safer and more fun to drive, even on long trips.

#### Ride Comfort

Improvements in chassis rigidity, suspension, and stabilisers efficiently absorb shocks from the road and hide uneven surfaces, allowing more comfort and less fatigue on long rides.

#### Comfortable Cabin Space

Unpleasant vibrations and noise have been reduced to ensure all passengers enjoy the ride. Suspension improvements and a highly rigid chassis allow for a comfortable cabin interior for all.



# Subaru All-Around Safety

At Subaru, safety comes first. That's why Subaru has been fine-tuning, testing, and retesting its advanced safety features. With the latest in collision protection/avoidance systems and core technologies like Subaru Global Platform and Symmetrical AWD, Subaru continues its 'people first' policy by improving All-Around Safety and envisions an accident-free future.

## PRIMARY

Outstanding visibility, optimal driving position, and intuitive controls help keep you safe from the moment you enter your vehicle.

## ACTIVE

Core technologies like Symmetrical AWD and Subaru Global Platform allow precise control of the basic elements of driving—driving, turning, and braking.

## PREVENTIVE

Advanced safety technologies such as EyeSight\*1 helps avoid collisions before they happen.

## PASSIVE

Designed to keep you safe in the event of a collision with features such as the cabin-protecting engine layout and SRS\*2 airbags.



### PRIMARY

#### Visibility in all directions

Easily check your surroundings. Optimal driving position, window heights, and carefully arranged pillars provide excellent visibility in all directions to reduce blind spots.



### ACTIVE

#### Auto Vehicle Hold (AVH)

Reduces driver fatigue when stopped at a signal, in traffic jams, or on a slope. AVH holds the vehicle in place even with your foot off the pedal when at a complete stop.



### ACTIVE

#### Vehicle Dynamics Control System

Adjusts AWD torque distribution, engine output, and brakes at each wheel to help keep the vehicle on course when making turns.

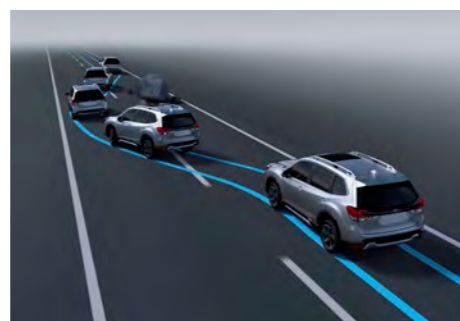

### ACTIVE

#### Hazard Avoidance

The low centre of gravity design, enhanced suspension system, and rigidity improvements provide a vehicle that responds immediately to driver input, helping avoid hazards on the road.



### PREVENTIVE

#### Steering Responsive Headlights (SRH)\*3

See better around corners in the dark for safer nighttime driving. These headlights turn with steering input to aim your lights in the direction your vehicle is turning.



### PREVENTIVE

#### High Beam Assist (HBA)\*3\*4

Increases visibility and safety when driving at night by toggling the high beams on and off automatically, depending on driving conditions.



### PREVENTIVE

#### Subaru Rear Vehicle Detection (SRVD)\*3\*4

Sensors in the rear corners alert you of vehicles in your rear blind spots for safer lane changes and warns you of potential collision danger while driving in reverse.



### PREVENTIVE

#### Reverse Automatic Braking (RAB)\*3\*4

Four sensors on the rear bumper detect obstructions behind the vehicle when reversing. If detected, the system can alert the driver with warning sounds and automatically apply the brakes to avoid a collision or reduce collision damage.



### PASSIVE

#### Ring-shaped Reinforcement Frame

Protects the cabin area with structurally redesigned high-tensile steel panels for better collision impact energy absorption from all directions.



### PASSIVE

#### Cabin-protecting Layout

The reinforced pillars and frame all work together within the Forester's Subaru Global Platform design to absorb collision impact from all sides to protect all passengers. In the event of a frontal collision, the engine and gearbox are designed to be pushed below the vehicle instead of crashing into the cabin.

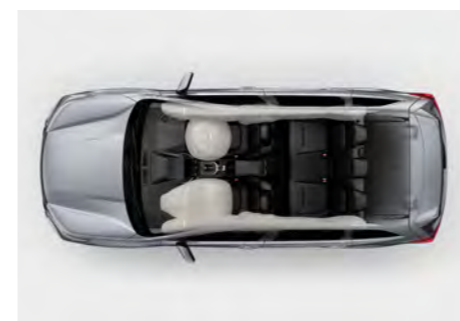

### PASSIVE

#### Supplemental Restraint System (SRS)\*2 Airbags

Front SRS\*2 airbags, front side SRS\*2 airbags, curtain SRS\*2 airbags, and a knee SRS\*2 airbag come standard on the Forester to give all passengers a higher level of protection in the event of a collision.

\*1 EyeSight is a driving support system which may not operate optimally under all driving conditions. The driver is always responsible for safe and attentive driving and observance of traffic regulations. System effectiveness depends on many factors such as vehicle maintenance, weather, and road conditions. See Owner's Manual for complete details on system operation and limitations for EyeSight, including functions in this brochure.

\*2 Effective when used in conjunction with seatbelts.

\*3 Optional.

\*4 The driver is always responsible for safe and attentive driving and observance of traffic regulations. Please do not depend solely on these safety features for safe driving. There are limitations to the features of this system. See Owner's Manual for complete details on system operation and limitations. Please ask your retailer for more details.



# Subaru EyeSight Driver Assist Technology

Completely re-engineered with a host of new and advanced functions, EyeSight\*<sup>1</sup> provides drivers with even more peace of mind on the road. Updates to both image recognition and control software, plus hardware improvements like windshield integration, enable even more confident and safer driving in many real-world driving situations.

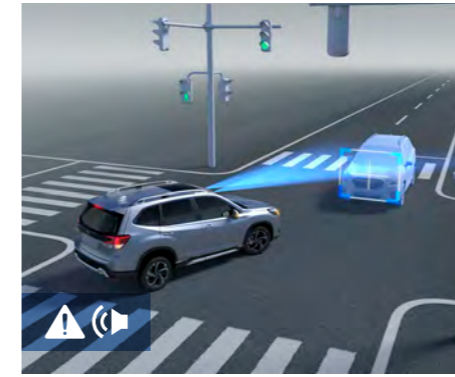

### Pre-Collision Braking System\*<sup>2</sup>

A new stereo camera with a wider angle of view and improved image recognition and control software helps avoid collisions at intersections.



### Autonomous Emergency Steering\*<sup>3</sup>

When Pre-Collision Braking Assist isn't enough, Autonomous Emergency Steering uses the stereo camera and rear radar to detect lane markings to judge if there is enough space to safely avoid a collision with an object ahead. If judged safe, it helps avoid a collision with automatic steering support.



### Adaptive Cruise Control

A comfort and convenience on long drives, Adaptive Cruise Control maintains a set distance from the vehicle ahead by continuously monitoring the distance and speed difference. Useful on freeways, highways, and similar roads, it can detect a lead vehicle and its brake lamps to keep pace in stop-and-go highway traffic.



### Lane Centring Control and Preceding Vehicle Adaptive Steering Control

Reduces driver fatigue and stress by recognising lane markings and the vehicle ahead to assist with steering wheel operation and help stay in the centre of the road.



### Lane Departure Prevention

Makes long drives stress-free by helping you stay in your lane. By recognising lane markings, and assisting with steering wheel operation, it can help keep your vehicle in the lane.



### Pre-Collision Throttle Management

When there is an object in front and you put the gear in Drive instead of Reverse, the system can alert you with a buzzer and flashing indicator and cuts engine power to minimise possible frontal impact force and damage.

For illustration purposes only. Not actual measurements.

\*<sup>1</sup> EyeSight is a driving support system which may not operate optimally under all driving conditions. The driver is always responsible for safe and attentive driving and observance of traffic regulations. System effectiveness depends on many factors such as vehicle maintenance, weather, and road conditions. See Owner's Manual for complete details on system operation and limitations for EyeSight including functions in this brochure.

\*<sup>2</sup> Pre-Collision Braking System may not work in all situations. Depending on the speed difference from objects, the object's height, and other conditions, every situation may not meet the necessary conditions for EyeSight to work optimally.

\*<sup>3</sup> Optional.

LINEUP



**FORESTER 2.0i-S EyeSight**

DIMENSIONS..... L x W x H: 4640 x 1815 x 1730 mm  
 POWER UNIT ..... Horizontally opposed, 4-cylinder, 2.0L DOHC 16-valve + Motor  
 CAPACITY..... 1995 cc  
 MAX OUTPUT..... SUBARU BOXER Engine: 110 kW (150 PS) / 5,600 - 6,000 rpm  
 Motor: 12.3 kW (16.7 PS)  
 MAX TORQUE..... SUBARU BOXER Engine: 194 Nm (19.8 kgfm) / 4,000 rpm  
 Motor: 66 Nm (6.7 kgfm)  
 TRANSMISSION..... Lineartronic, AWD



Crystal Black Silica

**FORESTER 2.5i-S EyeSight / 2.5i-Sport EyeSight / 2.5i-L EyeSight**

DIMENSIONS..... L x W x H: 4640 x 1815 x 1730 mm  
 ENGINE..... Horizontally opposed, 4-cylinder, 4-stroke, DOHC 16-valve, petrol  
 CAPACITY..... 2498 cc  
 MAX OUTPUT..... 136 kW (184 PS) / 5,800 rpm  
 MAX TORQUE..... 239 Nm (24.4 kgfm) / 4,400 rpm  
 TRANSMISSION..... Lineartronic, AWD



Cascade Green Silica

**FORESTER 2.0i-S EyeSight / 2.0i-S / 2.0i-L EyeSight / 2.0i-L**

DIMENSIONS..... L x W x H: 4640 x 1815 x 1730 mm  
 ENGINE..... Horizontally opposed, 4-cylinder, 4-stroke, DOHC 16-valve, petrol  
 CAPACITY..... 1995 cc  
 MAX OUTPUT..... 115 kW (156 PS) / 6,000 rpm  
 MAX TORQUE..... 196 Nm (20.0 kgfm) / 4,000 rpm  
 TRANSMISSION..... Lineartronic, AWD



Offshore Blue Metallic



**FORESTER 2.0i**

DIMENSIONS..... L x W x H: 4640 x 1815 x 1730 mm  
 ENGINE..... Horizontally opposed, 4-cylinder, 4-stroke, DOHC 16-valve, petrol  
 CAPACITY..... 1995 cc  
 MAX OUTPUT..... 115 kW (156 PS) / 6,000 rpm  
 MAX TORQUE..... 196 Nm (20.0 kgfm) / 4,000 rpm  
 TRANSMISSION..... Lineartronic, AWD



Ice Silver Metallic



**FORESTER 2.0i-Sport EyeSight**

DIMENSIONS..... L x W x H: 4640 x 1815 x 1730 mm  
 ENGINE..... Horizontally opposed, 4-cylinder, 4-stroke, DOHC 16-valve, petrol  
 CAPACITY..... 1995 cc  
 MAX OUTPUT..... 115 kW (156 PS) / 6,000 rpm  
 MAX TORQUE..... 196 Nm (20.0 kgfm) / 4,000 rpm  
 TRANSMISSION..... Lineartronic, AWD



Crystal White Pearl



## FEATURES



### 01 LED Headlamps

Be seen during the day and see well at night. Auto-levelling, bifunctional, and steering responsive\*, the stylish LED headlamps flow out from the hexagonal grille to display the vehicle's stylish and solid body.

### 02 18-inch Aluminium-alloy Wheels\*

The robustly styled multi-spoke 18-inch aluminium-alloy wheels are paired with 225/55R18 tyres.

### 03 LED Fog Lamps

See better at night or in poor weather. The round LED fog lamps are placed high for a large light coverage area and displays the vehicle's capability and functionality.

### 04 Front Grille

Bold and stylish, the expanded hexagonal grille gives off a powerful and wide stance as the headlamps and fog lamps dynamically flow out of the corners.

### 05 Roof Rails

Conveniently access the roof rails with the rear side sill steps. Use the rope holes to securely tie down your baggage or equipment.

### 06 Dual Air-conditioning System\*

The passenger-synced air-conditioning system efficiently provides a pleasant indoor cabin atmosphere to every occupied seat. Choose from four operation modes to adjust to anyone's temperature preference. For further convenience, you can also select your mode via the 6.3-inch Multifunction Display.

### 07 USB Power Outlets (Front and Rear)

USB charging ports are available for both front and rear seat passengers, increasing convenience for everyone.

### 08 Divided Seatback Pockets

Conveniently keep your magazines, smartphones, and tablets organised with the divided seatback pockets.

### 09 Seat Position Memory Switch

The seat memory function is linked to the position of the door mirrors for improved comfort and convenience. Plus, the passenger-side door mirror automatically tilts down when you shift into Reverse for better kerb visibility when backing up.

### 10 Rear Ventilation System

Vent grilles have been installed behind the centre console box so rear passengers can travel in comfort.

\* Optional.

## EXTERIOR COLOURS

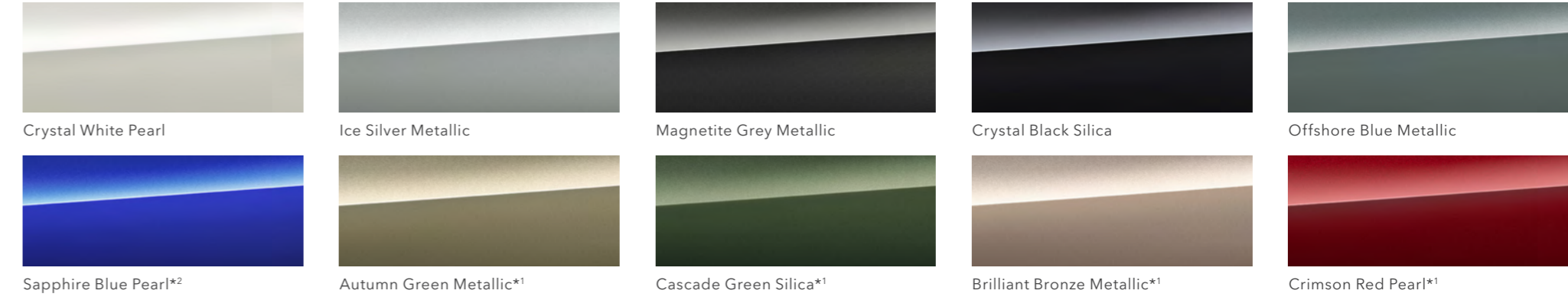

## SEAT MATERIALS

### Black Leather

(2.5i-S EyeSight / 2.0i-S EyeSight / 2.0i-S)\*3

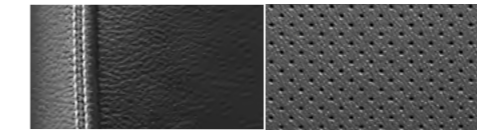

Seat Trim

Seat Backing

Silver Leather (2.0i-S EyeSight)\*4\*5



Seat Trim

Seat Backing

### Brown Leather

(2.5i-S EyeSight / 2.0i-S EyeSight / 2.0i-S)\*3\*4

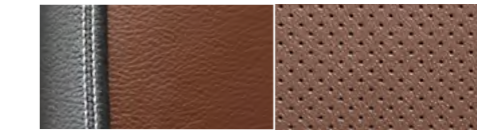

Seat Trim

Seat Backing

### Black Fabric

(2.5i-L EyeSight / 2.0i-L EyeSight / 2.0i-L)\*4

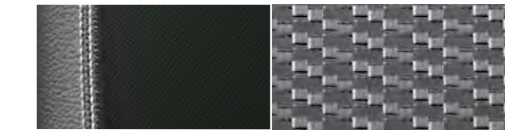

Seat Trim

Seat Backing

### Silver Fabric

(2.5i-L EyeSight / 2.0i-L EyeSight / 2.0i-L)\*4

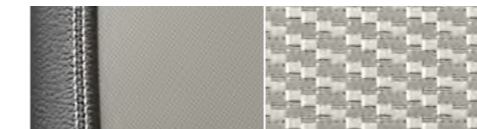

Seat Trim

Seat Backing

Black Fabric (2.0i)

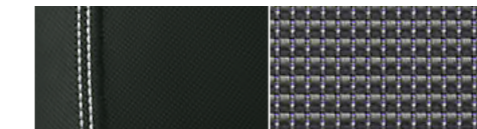

Seat Trim

Seat Backing

Silver Fabric (2.0i)

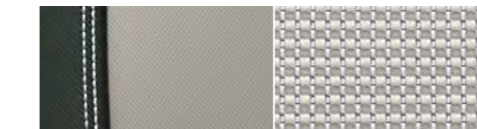

Seat Trim

Seat Backing

### Grey Sport Fabric

(2.5i-Sport EyeSight / 2.0i-Sport EyeSight)

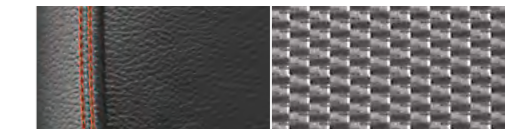

Seat Trim

Seat Backing

\*1 Not available on Sport models. \*2 Available only on Sport models. \*3 Optional.

\*4 Seat variations and/or combinations may vary according to region. \*5 Not available on SUBARU e-BOXER vehicles.

Owing to printing locations, colours may differ slightly from those shown in this chart. In addition, colours and seat variations may vary according to the individual market.

## DIMENSIONS

Dimensions are measured in accordance with standard measurement of SUBARU CORPORATION.

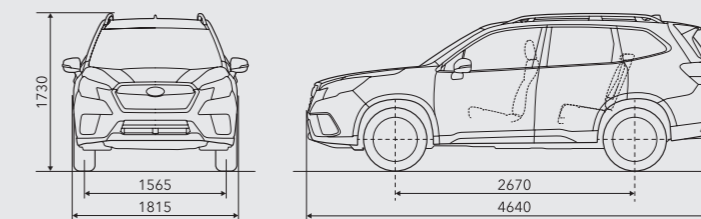

Not all features, options, or packages are available for all models and regions. See your specification sheet for availability. Please contact your local authorised Subaru retailer for more details.

SUBARU CORPORATION reserves the right to alter specifications and equipment without notice. Details of specifications, equipment, colour availability and lineup are subject to suit local conditions and requirements. Please inquire at your local retailer for details of any changes that might be required for your area.

